

## Angioplasty Accessories

*Inflation devices are specialized syringes used in interventional catheterization procedures to inflate balloon-tipped catheters. Merit Medical is the world market leader in digital and analog inflation devices which incorporate patented, proprietary design features.*

ANGIOPLASTY ACCESSORIES





## ANGIOPLASTY ACCESSORIES

Basix™ COMPAK Inflation Devices	I.1, 2, 3
Basix™ Inflation Devices	I.4
Viceroy™ Inflation Devices	I.5
Monarch® Inflation Devices	I.6, 7
IntelliSystem® Inflation Devices	I.8, 9
IntelliSystem® II Color Monitor & Accessories	I.10
IntelliSystem® Mounting Brackets & Accessories	I.11
IntelliSystem® Monitor & Accessories	I.12
Hemostasis Valves / Torque Devices / RXP™	I.13
Merit® Angioplasty Packs (MAP)	I.14

**BASIX™ COMPAK INFLATION SYRINGE** 30 ATM analog inflation device with 13" (35.5cm) extension tubing and angled gauge. 3-way stopcock included separately. Packaged 5 units per box, 4 boxes per case.

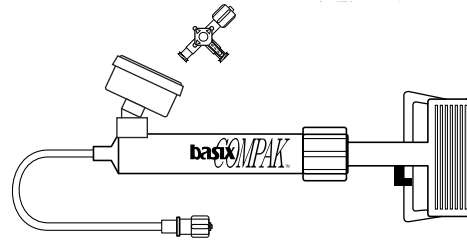

CATALOG NUMBER

IN4130

**BASIX™ COMPAK INFLATION SYRINGE** 30 ATM analog inflation device with angled gauge, 13" (35.5cm) extension tubing and Merit Angioplasty Pack (MAP). MAP includes large bore hemostasis valve, metal guide wire insertion tool and torque device. 3-way stopcock included separately. Packaged 5 kits per box, 4 boxes per case.

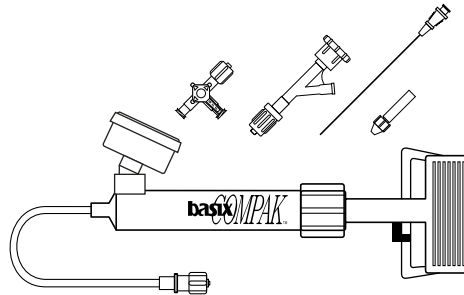

with Access-9™

with Access-PLUS™

with MBA

CATALOG NUMBER

IN4230

IN4530

IN4430

ANGIOPLASTY ACCESSORIES



**BASIX™ COMPAK INFLATION SYRINGE** 30 ATM analog inflation device with 13" (35.5cm) extension tubing and with 10ml Red Nitro & 10ml Yellow Heparin Medallion® Syringes. 3-way stopcock included separately. Packaged 5 kits per box, 4 boxes per case.

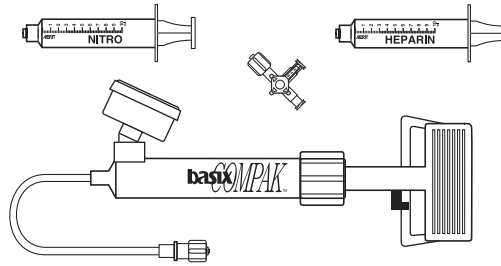

CATALOG NUMBER K05-00807

**BASIX™ COMPAK INFLATION SYRINGE** 30 ATM analog inflation device with angled gauge, 13" (35.5cm) extension tubing and Merit Angioplasty Pack (MAP). MAP includes large bore hemostasis valve, metal guide wire insertion tool, torque device and RXP™, rapid exchange prep syringe. 3-way stopcock included separately. Packaged 5 kits per box, 4 boxes per case.

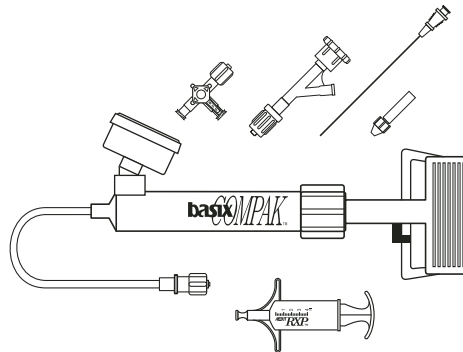

CATALOG NUMBER K05-01840

**BASIX™ COMPAK INFLATION SYRINGE** 30 ATM analog inflation device with 13" (35.5cm) extension tubing and 20ml VacLok® syringe. 3-way stopcock included separately. Packaged 5 kits per box, 4 boxes per case.

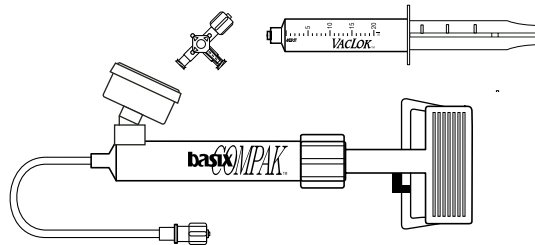

CATALOG NUMBER K05-00812

**BASIX™ COMPAK INFLATION SYRINGE** 30 ATM analog inflation device with 13" (35.5cm) extension tubing, includes Access-9™ large bore hemostasis valve. 3-way stopcock included separately. Packaged 5 kits per box, 4 boxes per case.

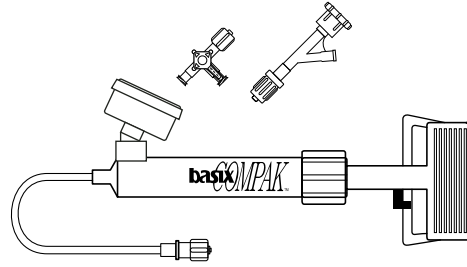

CATALOG NUMBER

K05-00892

**BASIX™ COMPAK INFLATION SYRINGE** 30 ATM analog inflation device with 13" (35.5cm) extension tubing and 10ml red NITRO Medallion® syringe. 3-way stopcock included separately. Packaged 5 kits per box, 4 boxes per case.

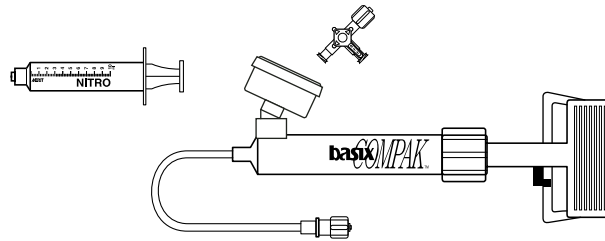

CATALOG NUMBER

K05-00808

**BASIX™ COMPAK INFLATION SYRINGE** 30 ATM analog inflation device with 13" (35.5cm) extension tubing, Merit Angioplasty Pack (MAP) and 10ml red NITRO Medallion® syringe. MAP includes Access-9 large bore hemostasis valve, metal guide wire insertion tool and torque device. 3-way stopcock included separately. Packaged 5 kits per box, 4 boxes per case.

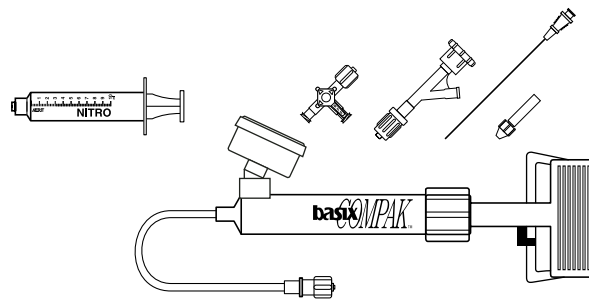

CATALOG NUMBER

K05-00842

**BASIX™ INFLATION SYRINGE** 25 ATM analog inflation device with 13" (35.5cm) extension tubing. 3-way stopcock included separately. Packaged 5 units per box, 4 boxes per case.

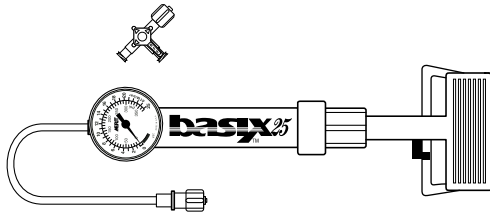

CATALOG NUMBER

IN3125

**BASIX™ INFLATION SYRINGE** 25 ATM analog inflation device with 13" (35.5cm) extension tubing and Merit Angioplasty Pack (MAP). MAP includes large bore hemostasis valve, metal guide wire insertion tool and torque device. 3-way stopcock included separately. packaged 5 kits per box, 4 boxes per case.

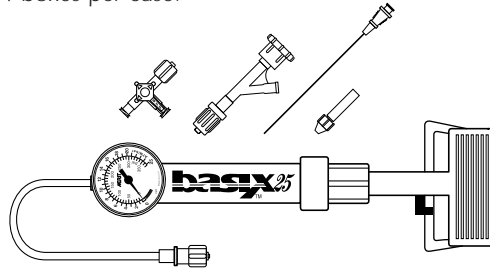

with Access-9™

with Access-PLUS™

with MBA

CATALOG NUMBER

IN3225

IN3525

IN3425

**VICEROY™ INFLATION SYRINGE WITH GAUGE** 30 ATM analog inflation device with 13" (35.5cm) extension tubing. Packaged 5 units per box, 4 boxes per case.

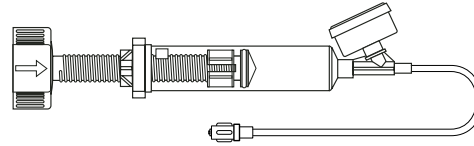

	10ml	20ml
CATALOG NUMBER	V1030	V2030

**VICEROY™ INFLATION SYRINGE WITHOUT GAUGE** with airless rotor. Packaged 5 kits per box, 4 boxes per case.

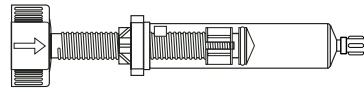

	10ml	20ml	60ml
CATALOG NUMBER	V1001	V2001	V6001

**VICEROY™ INFLATION SYRINGE** 10 ATM analog inflation device with 13" (35.5cm) extension tubing. Packaged 5 units per box, 4 boxes per case.

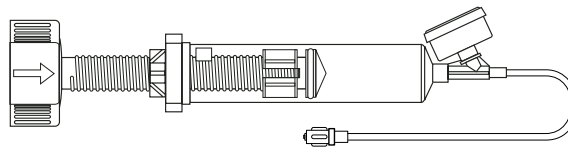

	60ml
CATALOG NUMBER	V6010

**MONARCH® INFLATION SYRINGE** 30 ATM digital inflation device with 13" (35.5cm) extension tubing. 3-way stopcock included separately. Packaged 5 units per box, 4 boxes per case.

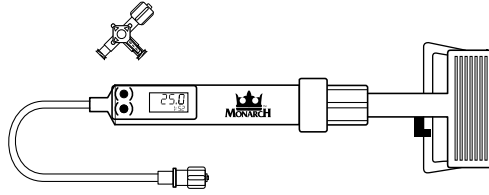

CATALOG NUMBER

IN2130

**MONARCH® INFLATION SYRINGE** 30 ATM digital inflation device with 13" (35.5cm) extension tubing and Merit Angioplasty Pack (MAP). MAP includes large bore hemostasis valve, metal guide wire insertion tool and torque device. 3-way stopcock included separately. Packaged 5 kits per box, 4 boxes per case.

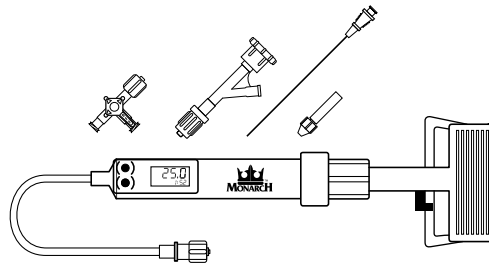

with Access-9™

with Access-PLUS™

with MBA

CATALOG NUMBER

IN2230

IN2530

IN2430

**MONARCH® INFLATION SYRINGE** 30 ATM digital inflation device with 13" (35.5cm) extension tubing and Merit Angioplasty Pack (MAP). MAP includes Passage® hemostasis valve, metal guide wire insertion tool and torque device. 3-way stopcock included separately. Packaged 5 kits per box, 4 boxes per case.

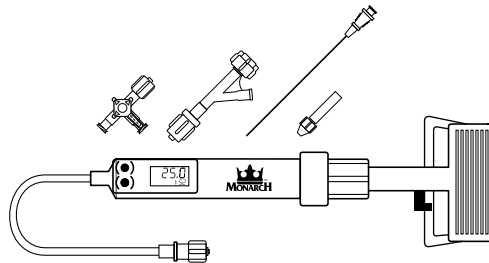

CATALOG NUMBER

K05-00787

**MONARCH® INFLATION SYRINGE** 30 ATM digital inflation device with 13" (35.5cm) extension tubing, Merit Angioplasty Pack (MAP) and 10ml red NITRO Medallion® syringe. MAP includes Access-9™ large bore hemostasis valve, metal guide wire insertion tool and torque device. 3-way stopcock included separately. Packaged 5 kits per box, 4 boxes per case.

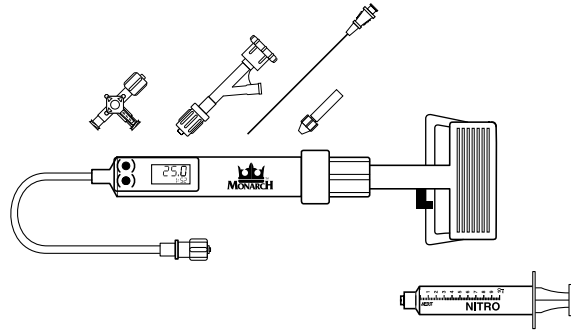

CATALOG NUMBER

K05-00793

**MONARCH® INFLATION SYRINGE** 30 ATM digital inflation device with 13" (35.5cm) extension tubing and 10ml red NITRO Medallion® syringe. 3-way stopcock included separately. Packaged 5 kits per box, 4 boxes per case.

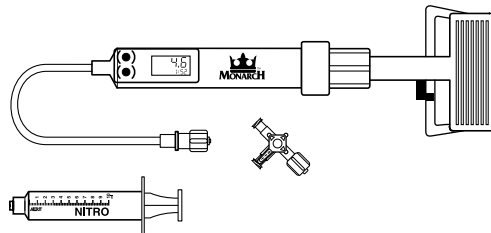

CATALOG NUMBER

K05-00802

**MONARCH® INFLATION SYRINGE** 30 ATM digital inflation device with 13" (35.5cm) extension tubing and 20ml VacLok® syringe. 3-way stopcock included separately. Packaged 5 kits per box, 4 boxes per case.

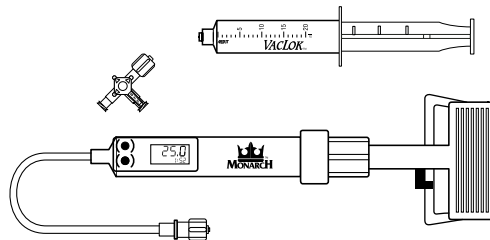

CATALOG NUMBER

K05-00811

**INTELLISYSTEM® DIGITAL INFLATION SYRINGE** with 13" (35.5cm) extension tubing.  
 3-way stopcock included separately. Packaged 5 units per box, 4 boxes per case.

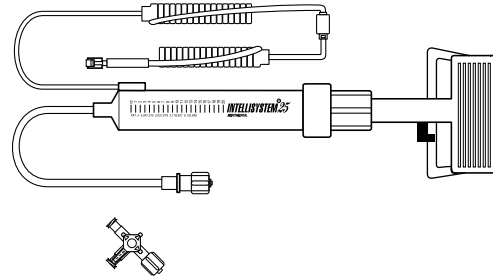

CATALOG NUMBER

IN1125

.....  
**INTELLISYSTEM® DIGITAL INFLATION SYRINGE** with 13" (35.5cm) extension tubing and Merit  
 Angioplasty Pack (MAP). MAP includes large bore hemostasis valve, metal guide wire insertion tool and torque device.  
 3-way stopcock included separately. Packaged 5 kits per box, 4 boxes per case.

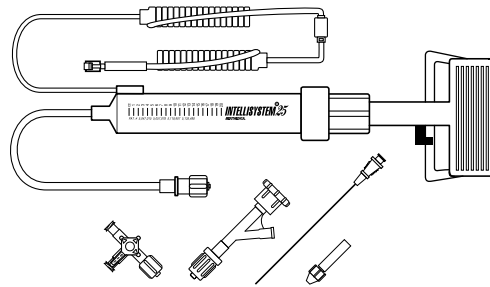

with Access-9™

with Access-PLUS™

with MBA

CATALOG NUMBER

IN1225

IN1525

IN1425

**INTELLISYSTEM® DIGITAL INFLATION SYRINGE** with 13" (35.5cm) extension tubing, Merit Angioplasty Pack (MAP) and 10ml red NITRO Medallion® syringe. MAP includes Access-9™ large bore hemostasis valve, metal guide wire insertion tool and torque device. 3-way stopcock included separately. Packaged 5 kits per box, 4 boxes per case.

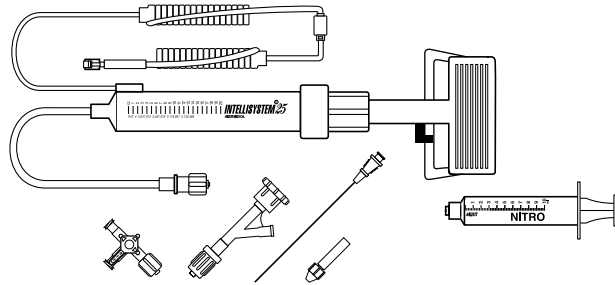

CATALOG NUMBER

K05-00800

**INTELLISYSTEM® DIGITAL INFLATION SYRINGE** with 13" (35.5cm) extension tubing and 10ml red NITRO Medallion® syringe. 3-way stopcock included separately. Packaged 5 kits per box, 4 boxes per case.

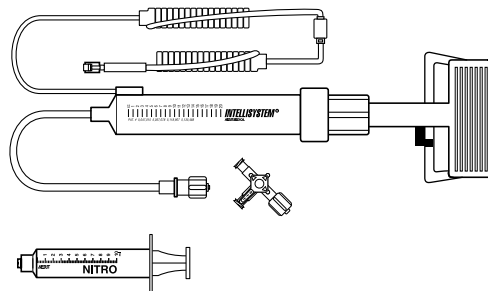

CATALOG NUMBER

K05-00791

**INTELLISYSTEM® DIGITAL INFLATION SYRINGE** with 13" (35.5cm) extension tubing and 20ml VacLok® Syringe. 3-way stopcock included separately. Packaged 5 kits per box, 4 boxes per case.

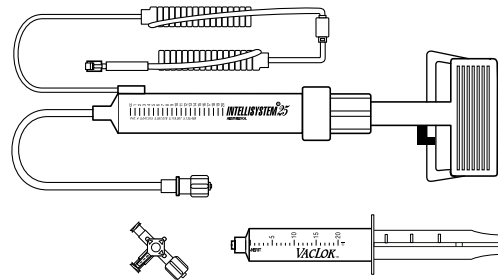

CATALOG NUMBER

K05-00810

**INTELLISYSTEM® II COLOR MONITOR** (and Remote Monitor) with touch screen and multi-language capability.

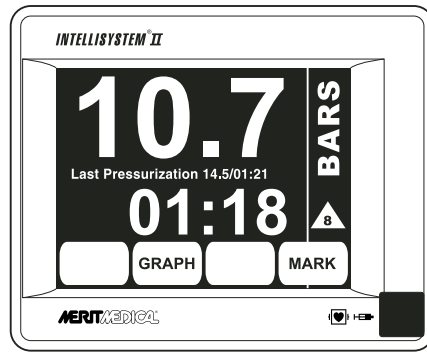

with 8' (2.4 m) hospital grade power cord and connector, 110 V	with 8' (2.4 m) hospital grade power cord and connector, 220 V 50 Hz United Kingdom	with 8' (2.4 m) hospital grade power cord and connector 220 V 50 Hz Continental Europe
---	---	--

CATALOG NUMBERS	IN6000	IN6050	IN6100
-----------------	--------	--------	--------

**INTELLISYSTEM® II THERMAL DOT MATRIX PRINTER**

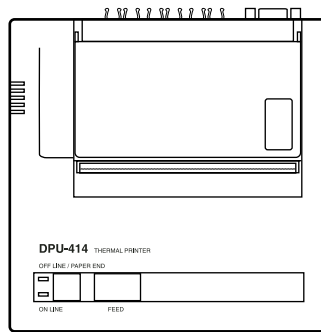

With 110 V adapter and fiber optic serial interface 33' (10m) cable	With 220 V 50 Hz adapter and fiber optic serial interface 33' (10m) cable
---	---

CATALOG NUMBERS	IN1600	IN1615
-----------------	--------	--------

**INTELLISYSTEM® II CABLES**

Fiber optic serial interface cable						
3' (1m)	10' (3m)	16.5' (5m)	26' (8m)	30' (9m)	65.5' (20m)	164' (50m)

CATALOG NUMBERS	900223002	900223003	900223004	900223005	900223001	900223006	900223007
-----------------	-----------	-----------	-----------	-----------	-----------	-----------	-----------

**INTELLISYSTEM® AND INTELLISYSTEM® II MONITOR MOUNTING KIT** for table side rails, includes mounting pole, sliding rail clamp and mounting bracket

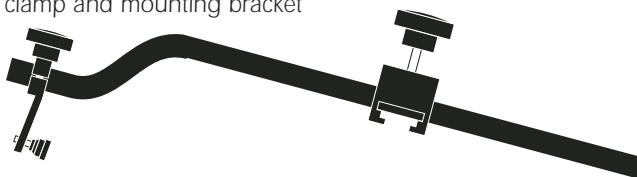

CATALOG NUMBER IN1300

**INTELLISYSTEM® AND INTELLISYSTEM® II MONITOR FIXTURES AND BRACKETS**

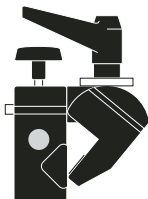

Pole Clamp\*



Swivel Connector\*

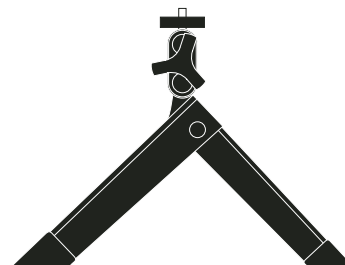

Tripod

CATALOG NUMBERS 909421 909420 701106001

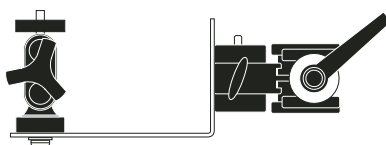

Pole Clamp and Bracket

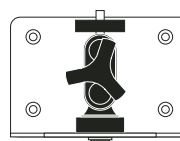

Wall Bracket

CATALOG NUMBERS IN1460 IN1450

**INTELLISYSTEM® AND INTELLISYSTEM® II ACCESSORIES**

Printer Paper Refill  
4.4" x 36"  
(112mm x 11m)



IntelliCheck™, Calibration  
Troubleshooting Tool

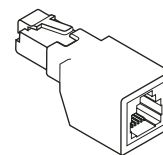

RJ-11 Extender/Adapters  
Box of 5

CATALOG NUMBERS 909401 IN5500 IN1111

\* Not recommended for IntelliSystem II Color Monitor.

## INTELLISYSTEM® MONITOR

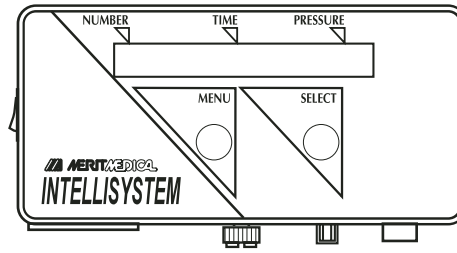

110 V

CATALOG NUMBER IN5000

## INTELLISYSTEM® THERMAL DOT MATRIX PRINTER with 6' (1.8m) cable.

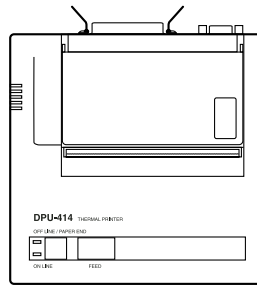

110 V

CATALOG NUMBER IN1200

## INTELLISYSTEM® PRINTER INTERFACE CABLE

6' (1.8m)

CATALOG NUMBER IN1250 (909402)

## INTELLISYSTEM® REMOTE MONITOR

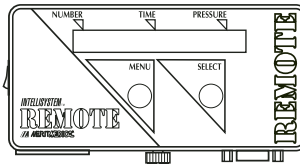

CATALOG NUMBER IN5300

## INTELLISYSTEM® REMOTE MONITOR CABLE

50' (15m) Length

100' (30m) Length

CATALOG NUMBERS IN1380-50 (909243003) IN1380-100 (909243005)

**MERIT® HEMOSTASIS VALVES AND ACCESSORIES** are sold individually.  
 Packaged 25 units per box, 4 boxes per case.

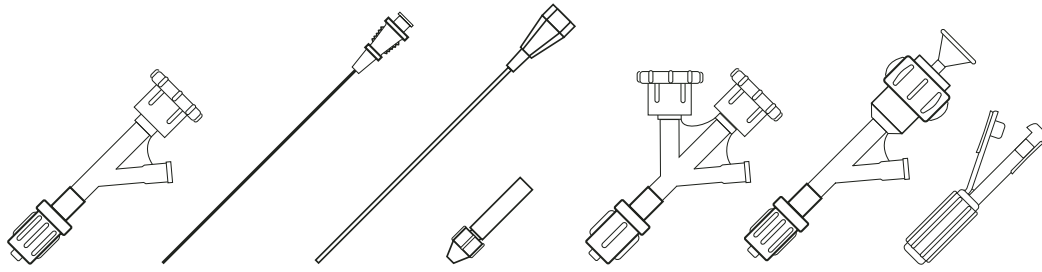

AccessPLUS™ Large Bore Hemostasis Valve 9F	Metal Guide Wire Insertion Tool	Plastic Guide Wire Insertion Tool	Torque Device .009" - .018"	DoublePlay™ Large Bore Double Y Hemostasis Valve 9F	MBA Large Bore Dual Seal Hemostasis Valve 9F	H <sub>2</sub> O TORQ™ Device .010" - .020"
--	--	--	-----------------------------------	--	---	---

CATALOG NUMBERS

MAP150	AccessPLUS™, Large Bore, Hemostasis Valve
MAP550	Metal Guide Wire Insertion Tool
MAP600	Plastic Guide Wire Insertion Tool
MAP500	Torque Device (fluorescent pink)
MAP501	Torque Device (fluorescent green)
MAP220	DoublePlay™ Large Bore Double Y Hemostasis Valve
MAP400	MBA, Large Bore, Hemostasis Valve
MAP450	MBA, Large Bore, Hemostasis Valve with 10" (25.4 cm) tubing extension
TD200	H <sub>2</sub> O Torque Device

Note: Hemostasis valves are also available with tubing extensions upon special request.  
 Please allow six weeks lead time for custom orders.

**RXP™ - RAPID EXCHANGE PREP SYRINGE**

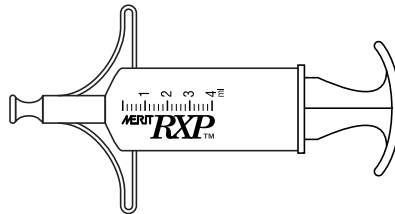

CATALOG NUMBERS      RXPOR

**MERIT® ANGIOPLASTY PACKS** (MAP) include Hemostasis Valve, your choice of Insertion Tool and/or Torque Device. Packaged 25 units per box, 4 boxes per case.

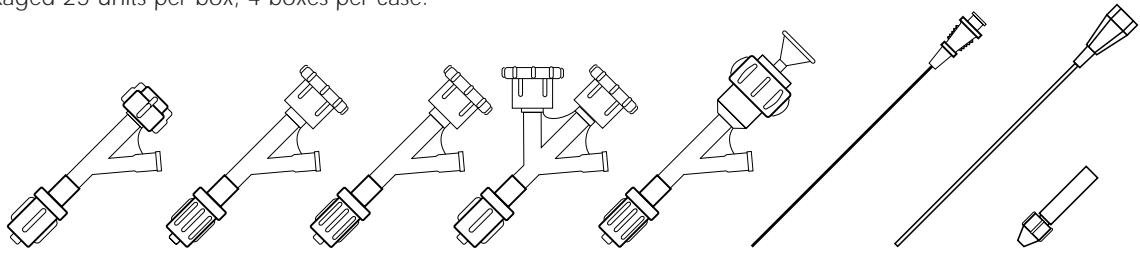

Passage® Hemostasis Valve 7.5F	Access-9™ Large Bore Hemostasis Valve 9F	AccessPLUS™ Large Bore Hemostasis Valve 9F	DoublePlay™ Large Bore Double Y Hemostasis Valve 9F	MBA Large Bore Dual Seal Hemostasis Valve 9F	Metal Guide Wire Insertion Tool	Plastic Guide Wire Insertion Tool	Torque Device .009" - .018"
---	--	--	--	---	--	--	-----------------------------------

CATALOG NUMBERS

MAP101	Passage® Hemostasis Valve with Metal Guide Wire Insertion Tool
MAP102	Passage Hemostasis Valve, Metal Guide Wire Insertion Tool and Torque Device
MAP103	Passage Hemostasis Valve with Plastic Guide Wire Insertion Tool
MAP104	Passage Hemostasis Valve, Plastic Guide Wire Insertion Tool and Torque Device
K12-00040	Passage Hemostasis Valve with 6" (15.2cm) 500psi (34 bar) bonded tubing extension
MAP111	Access-9™ Large Bore Hemostasis Valve with Metal Guide Wire Insertion Tool
MAP112	Access-9 Large Bore Hemostasis Valve, Metal Guide Wire Insertion Tool and Torque Device
MAP113	Access-9 Large Bore Hemostasis Valve with Plastic Guide Wire Insertion Tool
MAP114	Access-9 Large Bore Hemostasis Valve, Plastic Guide Wire Insertion Tool and Torque Device
MAP151	AccessPLUS™ Large Bore Hemostasis Valve with Metal Guide Wire Insertion Tool
MAP152	AccessPLUS Large Bore Hemostasis Valve, Metal Guide Wire Insertion Tool and Torque Device
MAP153	AccessPLUS Large Bore Hemostasis Valve with Plastic Guide Wire Insertion Tool
MAP154	AccessPLUS Large Bore Hemostasis Valve, Plastic Guide Wire Insertion Tool and Torque Device
MAP221	DoublePlay™, Double Y Hemostasis Valve with Metal Guide Wire Insertion Tool
MAP222	DoublePlay, Double Y Hemostasis Valve, Metal Guide Wire Insertion Tool and Fluorescent Pink and Green Torque Devices
MAP403	MBA Hemostasis Valve, Metal Guide Wire Insertion Tool and Torque Device
MAP453	MBA Hemostasis Valve with 10" (25.4cm) Extension Tubing, Metal Guide Wire Insertion Tool and Torque Device

Note: Hemostasis valves are also available with tubing extensions upon special request. Please allow six weeks lead time for custom orders.